



MEGA MODZ PS5 ADVANCED BACK BUTTONS

- [At Glance](#)
- [Introduction](#)
- [Color Sequence For Mapped Buttons](#)
- [Pairing Stock Buttons](#)
- [Sub-Modes](#)
- [Changing Sub-Modes](#)
- [Turning Back Buttons On & Off](#)
- [Setting Up On & Off Function for Mods](#)
- [DualSense Edge Back Button Assignments & Advanced Paddles Inputs Interaction](#)
- [Setting Up Custom Values for Turbo Function](#)
- [Reset to Factory Defaults](#)

Advertisement

AT GLANCE

The Mega Modz Advanced Back Buttons for the PS5 and DualSense Edge controllers can be tailored to any play style. They add versatility and performance while maintaining the comfort and feel of the PS5 and DualSense Edge wireless controllers at the same time.

Key Features

- **Two Tactile Rear Buttons** allow multiple configurations
- **Control LED Indicator** for easy profile customization
- **A dedicated button (Mod Switch)** to remap and configure inputs on the fly

Available Advanced Button Settings

There are 3 settings/sub-modes:

- **Straight Remap.** A traditional remap function (mimicking stock controller buttons inputs).
- **Turbo Mod***. Button mashing (holding a rear button produces a series of fast button presses).
- **Quick ON/OFF switch for MODS.** Both back buttons serve as ON/OFF switches for mods for instant in-game control.

***NOTE:** The user can configure the Turbo Mod timing sequences. The times that the stock buttons are pressed and released are programmable in

steps of seconds, hundreds of milliseconds, and tens of milliseconds.

Available Controller Configurations

Differ in the advanced level of the Back Buttons selected:

Option 1---Two Rear Buttons with Standard Remap only. Gives an edge in Online Gaming. ALLOWED IN ESPORTS & TOURNAMENTS (**PS5 DualSense Controller**).

Option 2---Two Advanced Rear Buttons with Standard Remap and Turbo Function for Online/Offline Gaming. Not allowed in tournaments (**PS5 DualSense Controller**).

Option 3---Two Rear Buttons with Standard Remap + MODS. A modded controller that is complemented with remappable buttons for Online/Offline gaming. Not allowed in tournaments (**PS5 DualSense Controller**).

Option 4---Advanced Rear Buttons with Standard Remap and Turbo Function + ON/OFF Switch for Mods + MODS. Online/Offline Gaming. Not allowed in tournaments (**PS5 DualSense & DualSense Edge Controller**).

Each Controller Setup can be configured in the [PS5 Controller Creator](#) or [DualSense Edge Controller Creator](#).

IN-DEPTH

NOTE: If your controller Back Buttons configuration is **Macro Remap**, then, [click here](#) to get to the correct instructions

Introduction

There are 3 main components besides the stock controller buttons involved in the process of configuring rear buttons.

Custom Indicator

It is a built-in LED board with advanced LEDs. It looks like a square consisting of 4 LEDs located next to each other. All four LEDs are mounted directly into the controller shell. If you're holding the controller shoulder buttons up then, Slot 1 - upper left; Slot 2 - upper right; Slot 3 - bottom left; Slot 4 - bottom right.

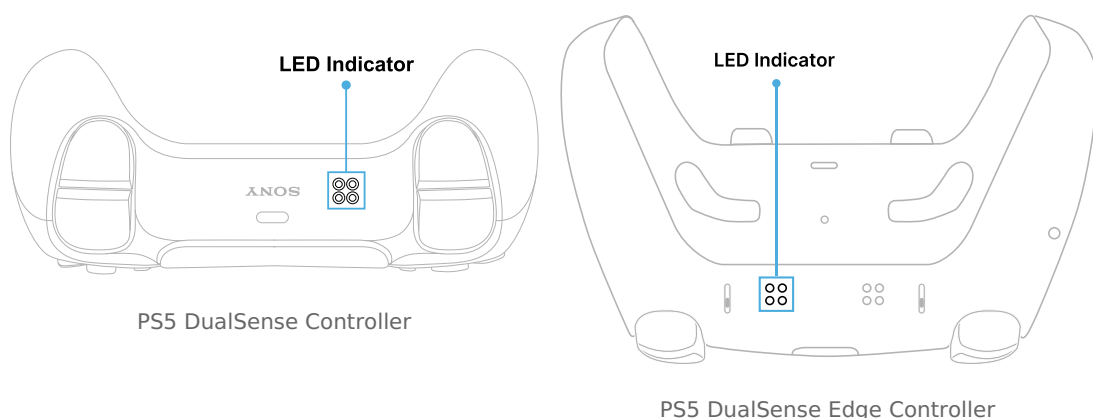

The LED Indicator lets the user interact with the modchip and be aware of what functions are active at any time. It also helps to scroll between sub-modes (If available), set up custom values (timing) for Turbo Mod, and get notifications about active configurations

in real time. Each stock button is color-coded when it gets assigned to the back buttons. At any given moment the user is able to detect which button is assigned, and what configuration and setup it represents.

Dedicated Mod Button

It is an additional built-in button located at the bottom center of the attachment. The main and only purpose of it is to simplify the configuration process. There is no need to press it for any other purposes during the gameplay.

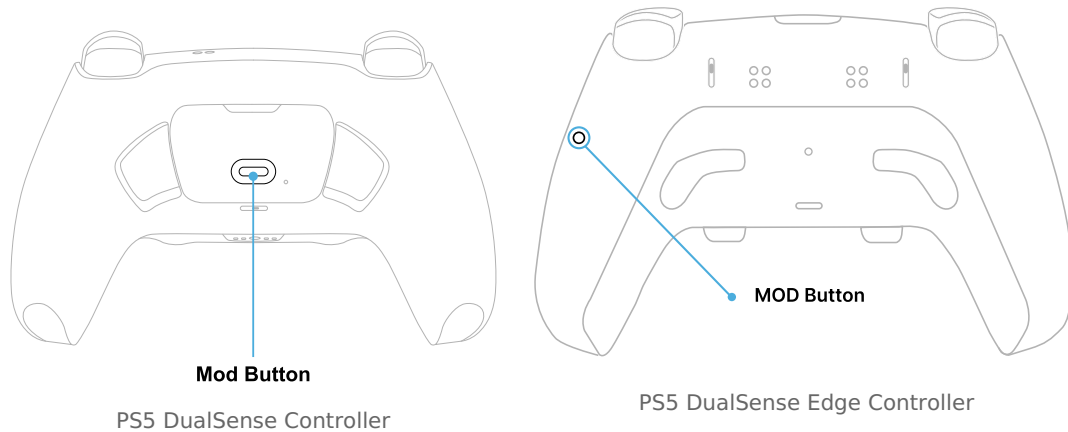

Advanced Back Buttons

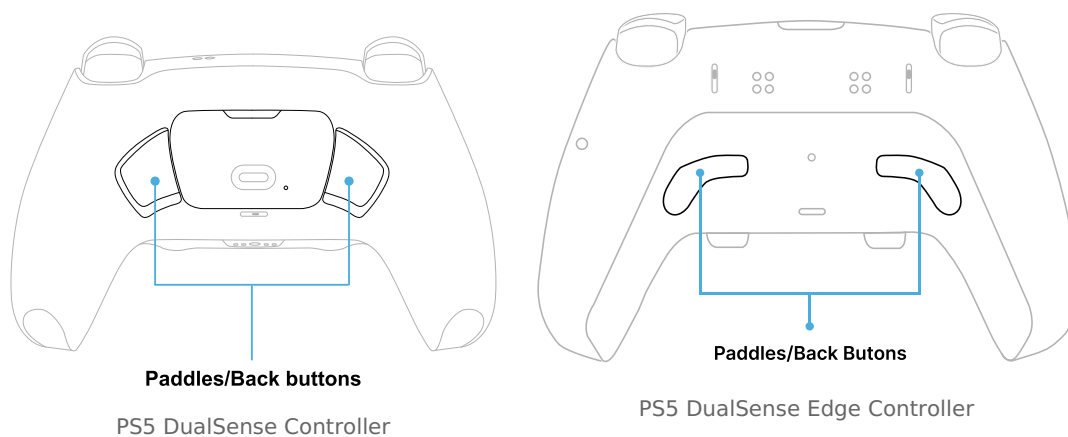

These two large ergonomic buttons are located on the back of the controller in the area of middle finger placement. The location of these buttons is very convenient because the user does not have to reach for them. To avoid any accidental clicks, the middle fingers can be moved up toward the center.









The Advanced Buttons are the main tool in the game. Once set up, they will perform a sequence of programmed instructions.

Color Sequence For Mapped Buttons

Color-coded LED lights help the user to better understand what's going on with the modchip and rear buttons. For instance, when a stock button gets assigned to a back button, the LED indicator will represent a button in the color according to the table below:

Stock Button	Color	
R1	Yellow	
R2	Red	
L1	Purple	

L2	Blue	
Left Stick	Green	
Right Stick	Pink	
Triangle	White	
Square	Light Blue	
X	Cyan	
Circle	Orange	
D-Pad Up		
D-Pad Down		
D-Pad Right		
D-Pad Left		

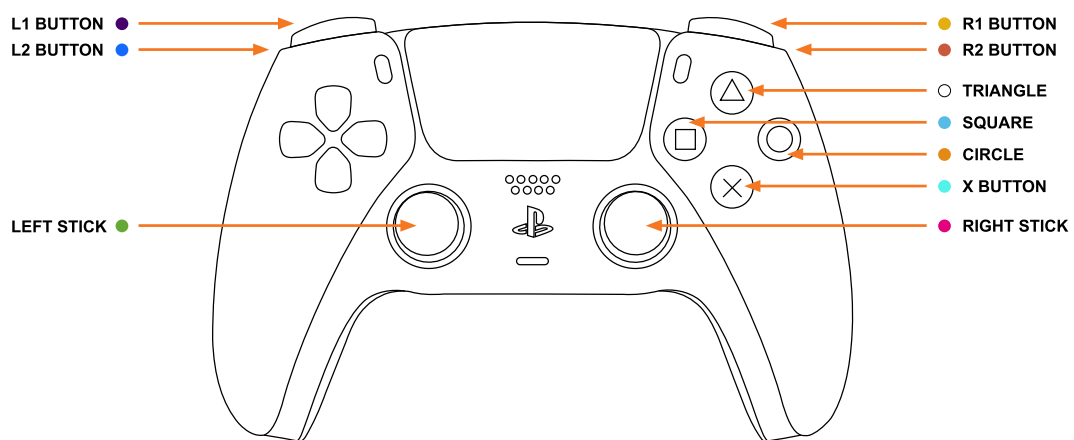

PS5 DualSense Controller

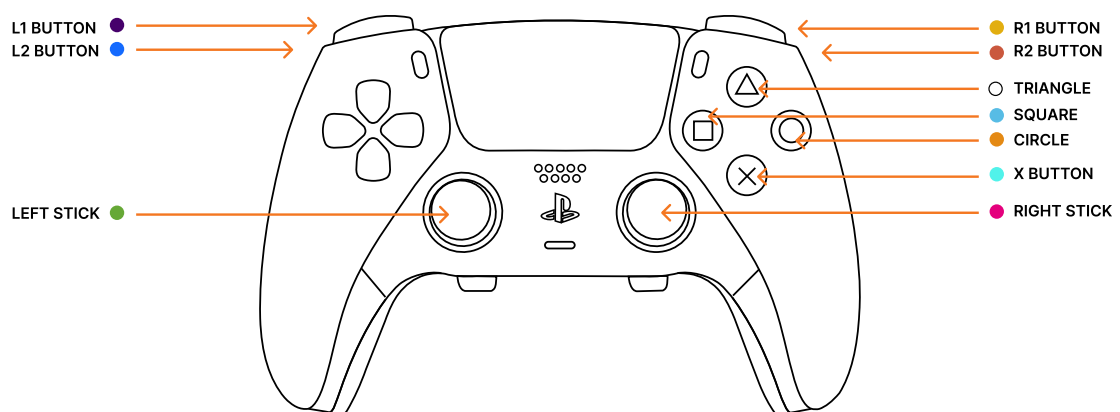

PS5 DualSense Edge Controller

Pairing Stock Buttons

In order to assign controller buttons to the back paddles please follow the following steps:

- Hold down the mod switch on the back, then hold down the rear button, and finally hold down the stock button to be assigned for 2 seconds.
- When the button is assigned, the LED Indicator will show the corresponding color in the Slot 1 or Slot 2 position (top row) corresponding to the left or right Back Button respectively.
- The rumble motors will vibrate for 1 second indicating the successful assignment of the

stock button.

Sub-Modes

Table showing sub-modes and their respective functions

Sub-Mode	Function	Notes	Adjustable Values
1	Simple Remap	Press the Macro Button and the modchip will mimic the stock button	No Adjustable Values
2	Turbo Function	Press and hold the Macro Button and the modchip will press and release the assigned stock button	The time between button presses and the time the button is pressed can be adjusted.

NOTE: The second sub-mode (Turbo function) is not available if only Straight Remap was selected in your **Back Buttons** configuration build. Not applicable to DualSense Edge Controller.

Changing Sub-Modes

Changing Advanced Button sub-modes:

- Make sure the back Button has been previously paired with a stock button and is currently active. (See "[Pairing Stock Buttons](#)" section)
- Hold down the mod button on the back.
- Then press and hold the back button for 2 seconds to enter the sub-mode menu.

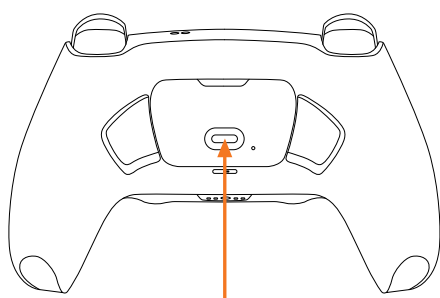

1 STEP. HOLD DOWN MOD BUTTON ON THE BACK

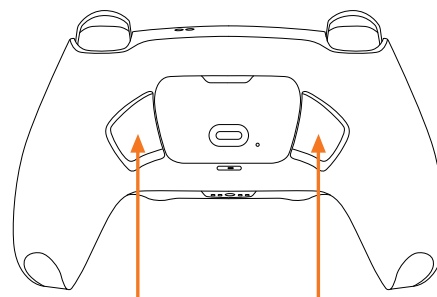

2 STEP. PRESS AND HOLD ONE OF THE BACK BUTTONS FOR 2 SEC

PS5 DualSense Controller

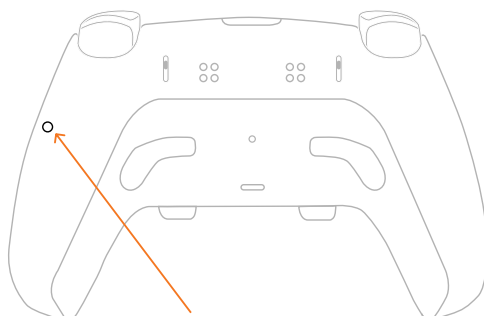

1 STEP. HOLD DOWN MOD BUTTON ON THE BACK

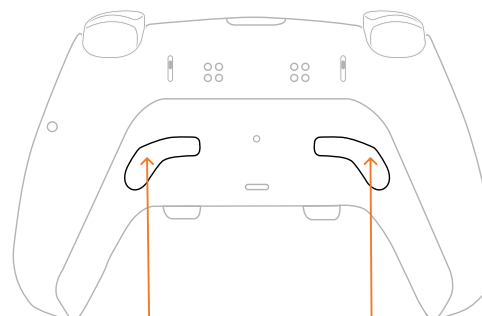

2 STEP. PRESS AND HOLD ONE OF THE BACK BUTTONS FOR 2 SEC

PS5 DualSense Edge Controller

The LED indicator will flash all 4 slots in GREEN showing that the modchip entered the sub-mode menu. It will then show the sub-mode that is active currently.

- 1ST Sub-mode - 1 Red LED, the top left LED slot is lit
- 2ND Sub-mode - 2 Red LEDs, top left and right slots are lit

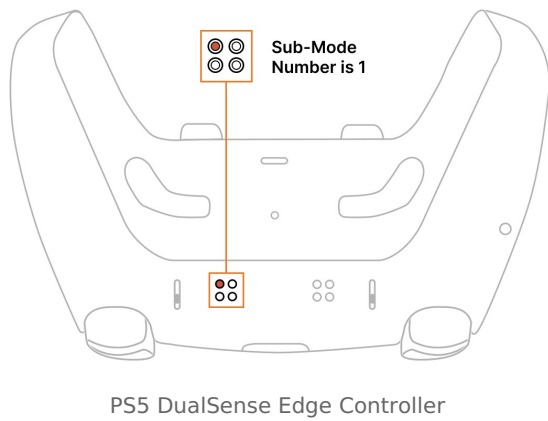
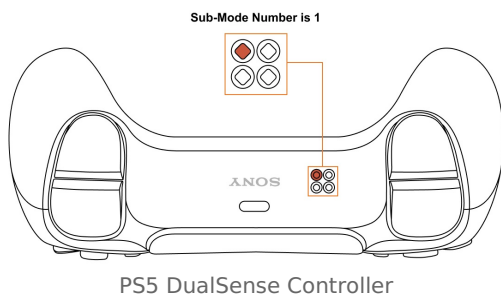

- Tap the R2 button to increase to the next sub-mode or tap the L2 button to decrease to the previous sub-mode.
- To save the setting press the Mod Button.

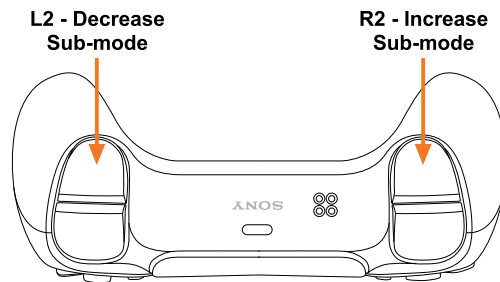

NOTE 1: Sub-modes function is not available if only Straight Remap was selected in your **Back Buttons** configuration build.

NOTE 2: Keep in mind, there is a "**3-second rule**" that applies every time you change sub-modes. If you've been inactive for more than 3 seconds, the modchip will exit the sub-mode menu without saving the settings.

Turning Back Buttons On & Off

Once a Back Button gets paired with a stock button, it automatically becomes active (See "[Pairing Stock Buttons](#)" section).

However, there is an option to turn a Back Button OFF.

- Hold down the mod button on the back.
- Then tap the Back Button you want to be turned OFF.

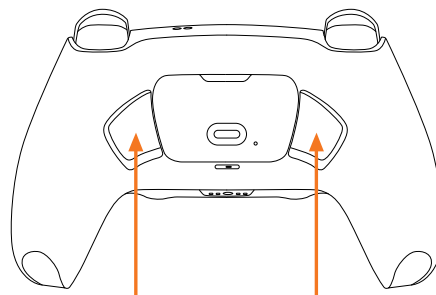
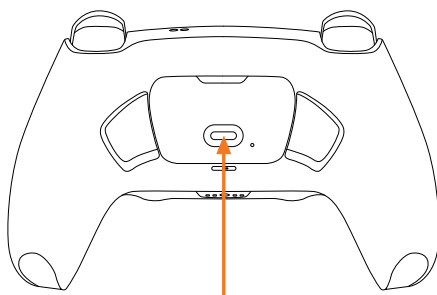

1 STEP. HOLD DOWN MOD BUTTON

2 STEP. TAP ONE OF THE BACK BUTTONS

PS5 DualSense Controller

PS5 DualSense Edge Controller

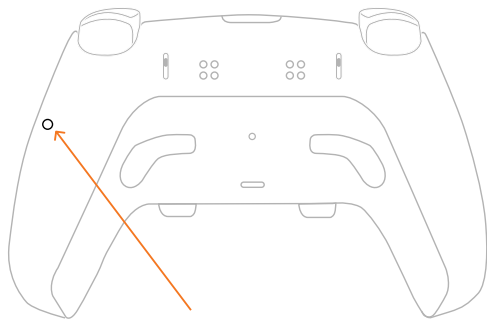

1 STEP. HOLD DOWN MOD BUTTON

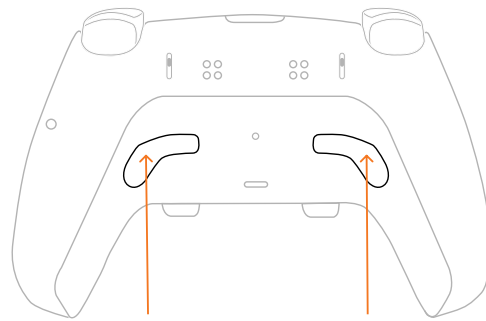

2 STEP. THEN TAP THE BACK BUTTON

The **Slot 1** or **Slot 2 LED** corresponding to the left or right back button will change its position to **Slot 3** or **Slot 4** respectively, indicating that the feature has been disabled.

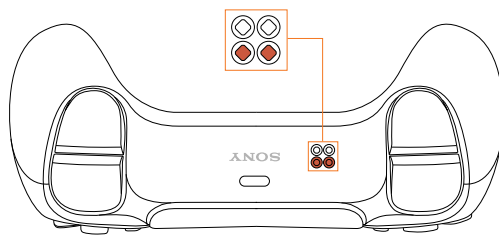

PS5 DualSense Controller

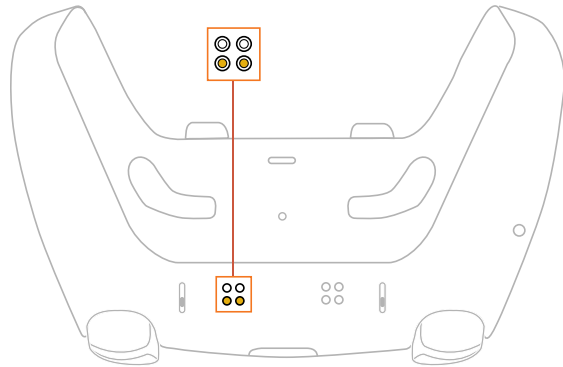

PS5 DualSense Edge Controller

You can enable the Back Button again by repeating the same steps as turning it OFF. (Hold Mod Button and Tap the Back Button)

NOTE: The controller always remembers the last Back Button setup before disabling it. Activating or pairing a Back Button with the same stock controller button will always return to the saved configuration the user has used previously (unless the reset to factory defaults was performed).

Setting Up On & Off Functions for Mods

If your controller configuration has **MODS** (Rapid Fire, Drop Shot, etc) and you have selected **Advanced Back Buttons** functionality in your configuration build, then, you can also configure Back Buttons as ON/OFF switches to disable/enable mods on the fly.

Shooting Mods (Slot 1 LED) and Special Mods (Slots 2-4 LED) gets disabled/enabled separately. In many game instances disabling MODS could be greatly beneficial. The function adds a whole new level of flexibility.

In order to configure the Quick ON/OFF switch for **Shooting Mods** follow these steps below:

- **Hold Down the mod button on the back.**
- **Then hold down the back button your want to be configured as an ON/OFF switch.**
- **Then double-tap on the R1 button quickly while holding the buttons mentioned above. Slots 1 or 2 (depending on the back button, Right or Left) will light up in dim Red indicating that one of the back buttons has been configured.**

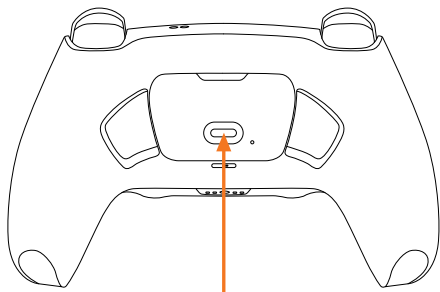

1 STEP. HOLD DOWN MOD BUTTON ON THE BACK

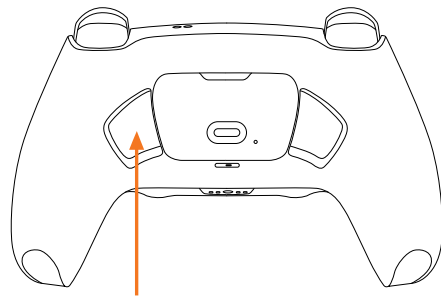

2 STEP. HOLD DOWN A BACK BUTTON YOUR WANT TO BE CONFIGURED AS AN ON/OFF SWITCH.

3 STEP.
DOUBLE-TAP ON THE R1 BUTTON QUICKLY



5 DualSense Edge Controller

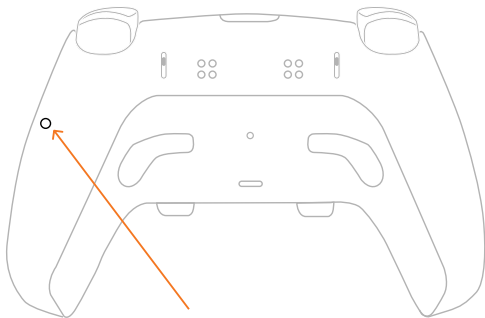

1 STEP. HOLD DOWN MOD BUTTON ON THE BACK

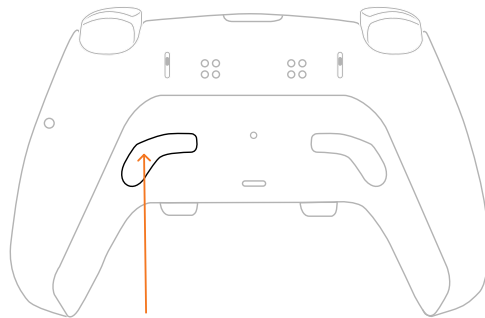

2 STEP. HOLD DOWN A BACK BUTTON YOUR WANT TO BE CONFIGURED AS AN ON/OFF SWITCH

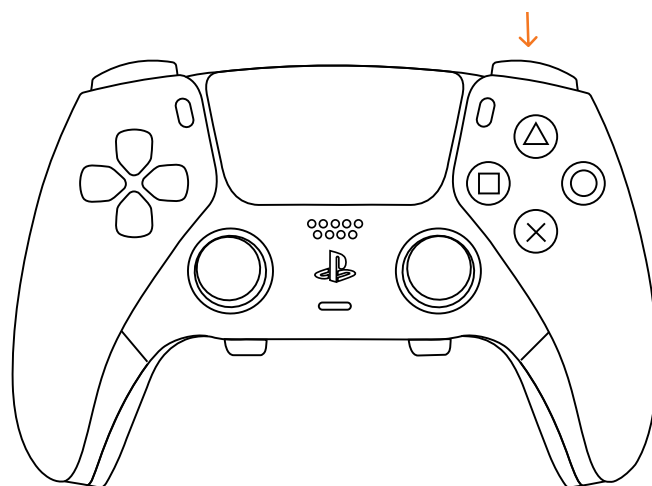

3 STEP. DOUBLE-TAP ON THE R1 BUTTON QUICKLY

In order to configure the Quick ON/OFF switch for **Special Mods** follow these steps below:

- Hold Down the mod button on the back.
- Then hold down the back button your want to be configured as an ON/OFF switch.

- Then double-tap on the **L1 button** quickly while holding the buttons mentioned above. Slots 1 or 2 (depending on the back button, Right or Left) will light up in Light Blue indicating that one of the back buttons has been configured.

PS5 DualSense Controller

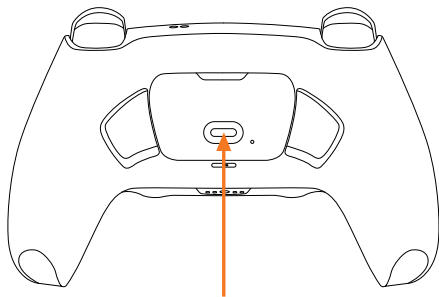

1 STEP. HOLD DOWN MOD BUTTON ON THE BACK

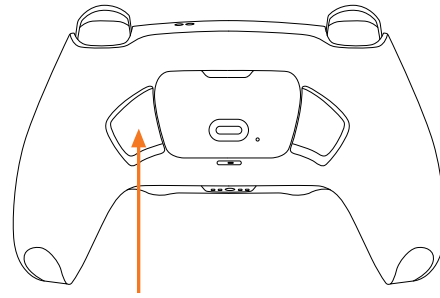

2 STEP. HOLD DOWN A BACK BUTTON YOU WANT TO BE CONFIGURED AS AN ON/OFF SWITCH.

3 STEP.
DOUBLE-TAP ON THE L1 BUTTON QUICKLY

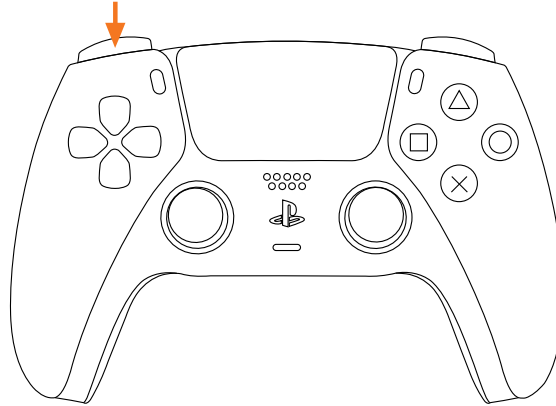

5 DualSense Edge Controller

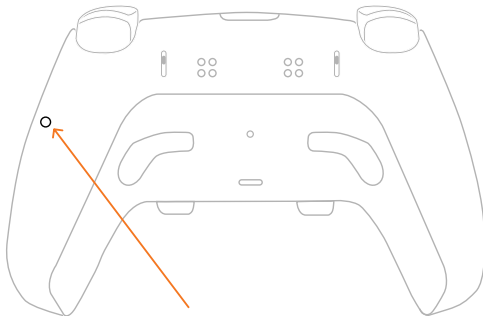

1 STEP. HOLD DOWN MOD BUTTON ON THE BACK

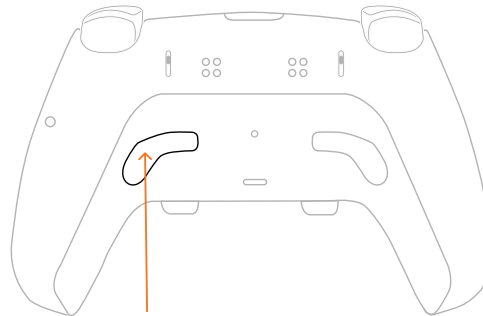

2 STEP. HOLD DOWN A BACK BUTTON YOU WANT TO BE CONFIGURED AS AN ON/OFF SWITCH

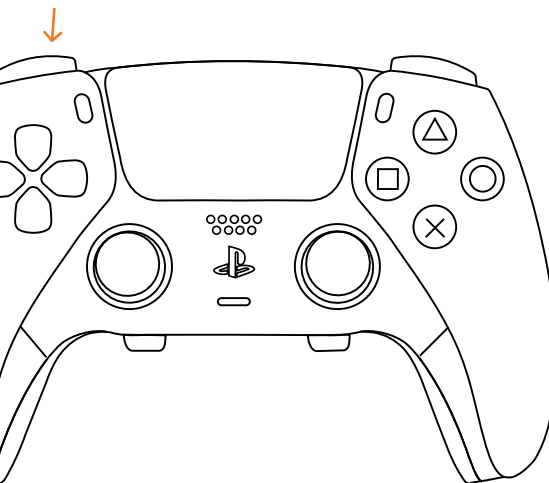

3 STEP. DOUBLE-TAP ON THE L1 BUTTON QUICKLY

In case, you have configured both back buttons as ON/OFF switches for either **Shooting** or **Special Mods** solely, then, the Left Paddle is always OFF function and the Right

paddle is always ON function.

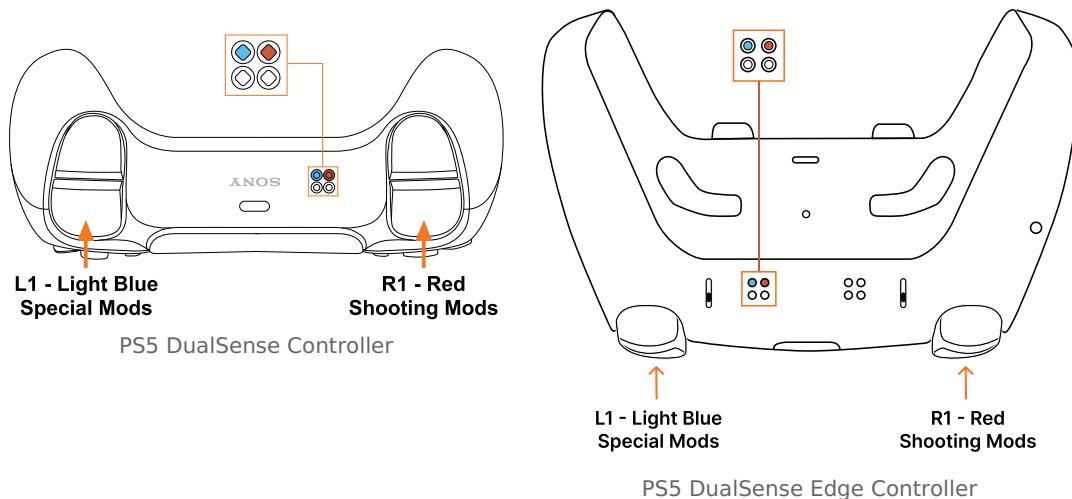

DualSense Edge Back Button Assignments & Advanced Paddles Inputs Interaction

The DualSense Edge allows creating custom profiles to customize the controller's button assignments including the Back Buttons through the controller user interface. This default feature operates independently of the Mega Modz Advanced Back Button Inputs. If you want to learn more about creating Custom Profiles in the PlayStation App, please visit [this page](#).

It is recommended that the controller back buttons in the Customization App be unassigned before configuring the Advanced Back Button Inputs on your Mega Modz Edge Controller.

Since the Custom Profiles in the App and the Advanced Button Inputs are two separate controller functions, it is possible to assign 2 controller stock buttons to one paddle:

- **One stock button is being assigned through the Controller Customization App.**
- **The other stock button is being assigned through the modchip interface. The one that gets assigned through the modchip can be further customized with 3 different Advanced Input sub-modes (Straight Remap, Turbo Function, ON/OFF quick switch for MODS) and custom timing or configuration allowing for more complex sequences on a single paddle press.**

Quick Example:

- **The stock button bound to the left paddle through the Customization App is a Jump Button.**
- **The stock Button bound to the left paddle through the modchip interface is a Fire Button.**

Mechanics:

Any time the user presses the **Left Paddle**, a character jumps and shoots simultaneously (**Jump Shot**). If the gun you are using is semi-automatic, you can further customize the functionality. By scrolling to the second sub-mode (**Turbo Function**), pressing the Left Paddle on the controller will now perform **Jump Shot & Rapid Fire** at the same time.

NOTE: Avoid binding 2 contradiction buttons/inputs to one paddle as it will confuse the controller and the gameplay may become unpredictable. A quick example of 2 contradicting buttons are the Jump and the Crouch/Going Prone buttons as these two actions cannot be performed simultaneously in a game or real world.

TIP: Use the quick Advanced Input **ON/OFF** function to your advantage whenever you have 2 buttons bound to one paddle (see the section above). In the example above, if you disable the Fire Button (configured through the modchip interface), you'll be left with only the Jump function (configured through the controller interface). Utilizing this technique will add flexibility to your gameplay as you can go back and forth to the different input configuration sequences on the fly.

Setting Up Custom Values for the Turbo Function

IMPORTANT: This section provides advanced settings and requires a full understanding of all the operations described above before proceeding.

The Turbo function (2ND Sub-mode) comes pre-configured with factory settings by default. However, since every game is different, the user is able to program the timing a button is being pressed (**ON button timing**) and the time between button presses (**OFF button timing**) via a programming mode.

Button timing is programmed by individually setting up seconds then hundreds of milliseconds, then tens of milliseconds. The minimum unit of time that can be changed is 50 ms. The software won't allow the user to go above and below the pre-programmed limits.

Sub-Mode	Min/Max ON Button Timing	Min/Max OFF Button Timing
1	N/A	N/A
2	50 ms - 3 sec <i>(default 100 ms)</i>	50 ms - 3 sec <i>(default 150 ms)</i>

When programming mode is entered (Mod Button + PS Home Button), the timing may be adjusted in the following order: seconds, then hundreds of ms, then tens of ms.

Programming Mode:

- Make sure the Back Button has been previously paired and is currently active. (See "[Pairing Stock Buttons](#)" section)
- Scroll to the 2ND sub-mode. (See "[Changing Sub-Modes](#)" section)
- Enter a programming mode by holding down the mod button on the back and pressing the PS Home button.

All four LEDs will light up in WHITE to let you know that it's waiting for further input.

- Tap the Back Button to edit "OFF button timing" (a pause between button presses).
- Or hold down the Back Button for 2 seconds to edit "ON button timing" (a stock button being pressed and released)

The modchip displays the "seconds" digit first.

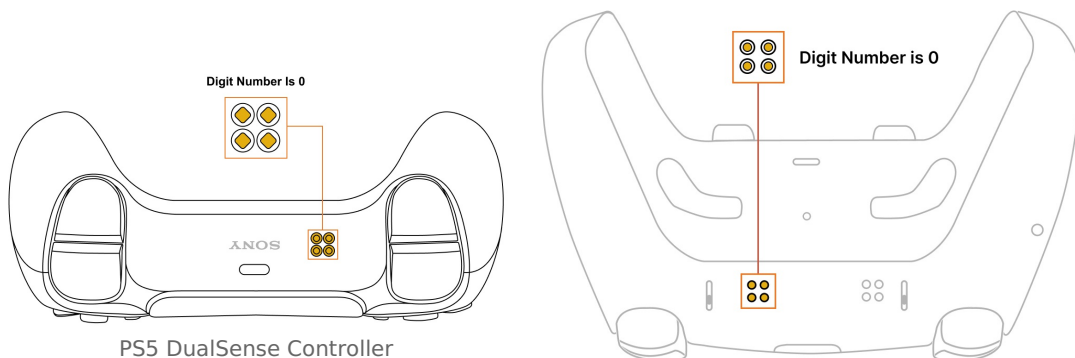

- Tap the **R2 button** to increase the seconds' digit or tap the **L2 button** to decrease the "seconds" digit. The modchip will display the current number. (1 digit on the LED Indicator represents 1 sec, 2 digits represents 2 sec, and so on)
- When the desired number of seconds is reached, tap the mod switch to save the seconds digit and move to the next number.

The modchip displays the "hundreds of milliseconds" digit.

- Tap the **R2 button** to increase the "hundreds of ms" digit or tap the **L2 button** to decrease the "hundreds of ms" digit. The modchip will display the current number. (1 digit on the LED Indicator represents 100 ms, 2 digits represents 200 ms, and so on)
- When the desired "tens of milliseconds" is reached, tap the mod switch to save the "tens of milliseconds" digit. The modchip will blink all 4 LEDs in red 3 times very quickly and exit the programming menu saving the last settings.

The modchip displays the "tens of milliseconds" digit.

- Tap the **R2 button** to increase the "tens of ms" digit or tap the **L2 button** to decrease the "tens of ms" digit. The modchip will display the current number. (1 digit on the LED Indicator represents 10 ms, 2 digits represents 20 ms, and so on)
- When the desired "tens of milliseconds" is reached, tap the mod switch to save the "tens of milliseconds" digit. The modchip will blink all 4 LEDs in red 3 times very quickly and exit the programming menu saving the last settings.

EXAMPLE: The button timing you need to configure is 2.340 seconds.
 Seconds: 2 seconds (digit 2 on the LED Indicator)
 Hundreds of milliseconds: 300 milliseconds (digit 3 on the LED Indicator)
 Tens of milliseconds: 40 milliseconds (digit 4 on the LED Indicator)
 2.340 seconds = 2 sec+300 ms+40 ms

NOTE 1: The controller always remembers the last custom timing configured.

NOTE 2: There is an "8-second rule" that applies to "Programming Mode". If there is inactivity for more than 8 seconds, the modchip will exit the programming menu automatically.

TIP: There is a "**Quick Speed Scroll**" option available on every Mega Modz Controller allowing the user to get to the desired value quickly and avoid waiting for the modchip to go through the sequence of digits.
 Quickly tapping the **R2 button** will increase the value by the number of times the R2 button was tapped, getting the user to the desired value quickly.
 Quickly tapping the **L2 button** will decrease the value by the number of times the L2 button was tapped, getting the user to the desired value quickly.

EXAMPLE: Value 1 is showing. Tapping the R2 button 2 times quickly increases the value to 3. Tapping on the R2 button 5 times quickly increases the value to 6.

Reset to Factory Defaults

The modchip allows the user to reset all configurations (sub-modes and timing) to the factory default settings and clear the Back Button Inputs.

Here are the steps:

PS5 DualSense Controller:

- **Hold down the mod switch and tap the PS-Home button, then release both buttons to enter “Programming Mode”.**

All four LEDs will glow WHITE indicating the mod is now awaiting further input.

- **Hold down the PS-Home button and tap D-Pad Down. A special WHITE blinking LED sequence will play and the modchip will reset itself back to the factory default settings.**

NOTE: If you entered “Programming Mode” accidentally or changed your mind on the way, you’ll have to wait 8 seconds for the modchip to exit “Programming Mode” automatically. There is no other way to exit the Programming Mode.

PS5 DualSense Edge Controller:

- **Hold down the mod switch and tap the D-pad UP button, then release both buttons to enter “Programming Mode”.**

All four LEDs will glow WHITE indicating the mod is now awaiting further input.

- **Hold down the D-pad UP button and tap the button X. A special WHITE blinking LED sequence will play and the modchip will reset itself back to the factory default settings.**

NOTE: If you entered “Programming Mode” accidentally or changed your mind on the way, you’ll have to wait 8 seconds for the modchip to exit “Programming Mode” automatically. There is no other way to exit the Programming Mode.

Having issues operating your Mega Modz Controller? Visit our [Community Forums](#) for troubleshooting.